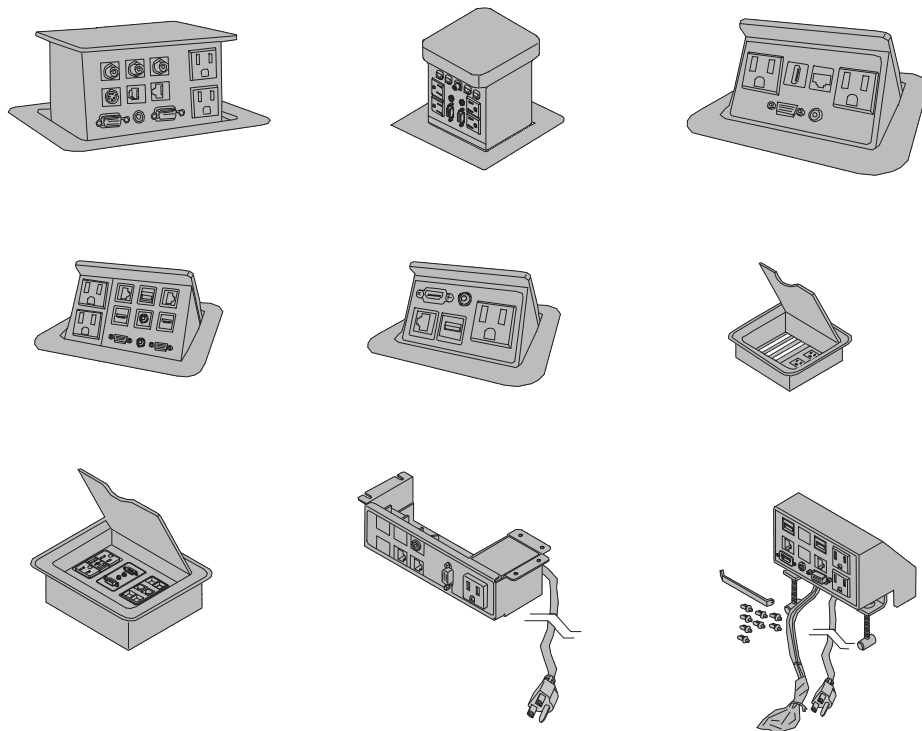

Table Top Interconnect Guide



About ALTINEX

ALTINEX has been the leading, ISO 9001 certified manufacturer of modular audiovisual signal management solutions™ since 1993. We manufacture a complete line of computer video interfaces, distribution amplifiers, switchers, matrix switchers, special application products, cables and related accessories, software, and a large variety of furniture connectivity products.

Signal management solutions are used to handle the routing of computer video, broadcast video, audio, and control signals in presentation systems which can range from a small meeting room to a multi-faceted large boardroom or conference room. The current product line includes a full array of designer solutions, interfaces, distribution amplifiers, switchers, matrix switchers, converters, special application products, cables, and accessories.

Many ALTINEX customers are large system integrators who expect their vendors to adhere to the same strict quality procedures that they follow in their own operations. ALTINEX products are marketed throughout the United States by a network of manufacturers representatives, pro audiovisual dealers, and systems integrators. ALTINEX products are also offered by pro audiovisual distributors in many other countries and regions throughout the world, including Canada, Mexico, South America, Europe, Israel, South Africa, China, Japan, Korea, Malaysia, and Australia. ALTINEX distinguishes itself by offering innovative solutions that deliver high performance and reliability and are Easy to use, Easy to install, and Easy to maintain.

Notes:

Pop 'N Plug (PNP40X series)

Dual Sided
Shipped Fully Assembled

Standard Units (Brushed Aluminum Bezel)

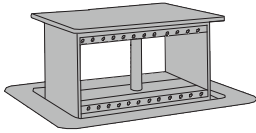

PNP400
(Black)

EMPTY ENCLOSURE
6 SLOTS PER SIDE

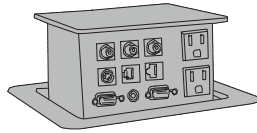

PNP402
(Black)

3 x RCA , S-Video, 2 x VGA,
3.5mm AUDIO, RJ-45, RJ-1, 2 x POWER

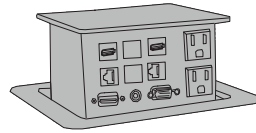

PNP408
(Black)

2 x USB 3.0, 2 x RJ-45, HDMI,
3.5mm AUDIO, VGA, 2 x POWER

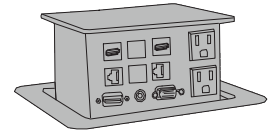

PNP408S
(Silver)

Factory Configured to Your Specification

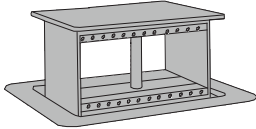

PNP400C
EMPTY ENCLOSURE
6 SLOTS PER SIDE

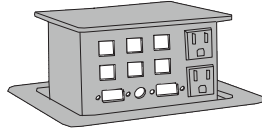

PNP402C
6 x SNAP-INS, 1 x 3.5mm AUDIO,
2 x D-SUB, 2 x POWER

This units are dual sided
These units are shipped fully assembled
Specify any Snap-In connector. See page 12 for Snap-In connectors
Specify Black or Silver bezel and cover
Configure unit Online, Using AVSnap or Send us your sketch.
Table cut-out template are available online
Bezel size: 7.86" x 6.53"
Depth below 1 inch table: 4.75"

Factory Configured Insert Plates (can be field upgraded)

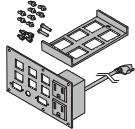

SP1100SC

6 SNAP-INS,
2 D-SUBS,
1 AUDIO, 2 POWER

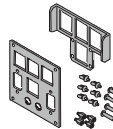

SP3212AV

4 EMPTY SNAP-INS,
2 D-SUBS, 2 AUDIO
(3 SLOTS)

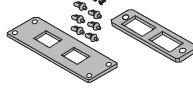

SP3102EP

DUAL EMPTY
SNAP-IN PORT
(1 SLOT)

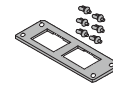

SP3103EP

DUAL EMPTY
ORTRONICS-ONLY
SNAP-IN PORT (1 SLOT)

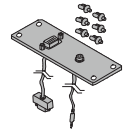

SP3201AV

1 VGA & 1 AUDIO
PLATE
(1 SLOT)

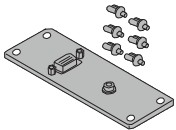

SP3202AV

VGA F/F GENDER
CHANGER, 1 AUDIO
(1 SLOT)

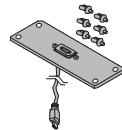

SP3210AV

HDMI SECTIONAL
PLATE (1 SLOT)

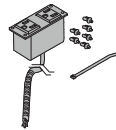

SP2107US

2 x POWER OUTLET
(NORTH AMERICA)
ATTACHED 12 FT. METAL
CONDUIT (2 SLOTS)

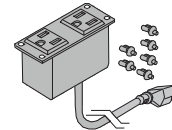

SP2102US

2 x POWER OUTLET
(NORTH AMERICA)
9FT POWER CABLE
(2 SLOTS)

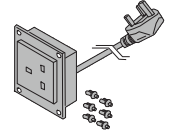

SP2201UK

POWER OUTLET
U.K./ SINGAPORE/
HONG KONG
(3 SLOTS)

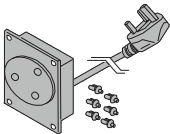

SP2501SA

POWER OUTLET
SOUTH AFRICA
(3 SLOTS)

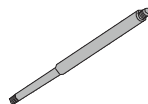

AC401-303

REPLACEMENT
GAS SPRING

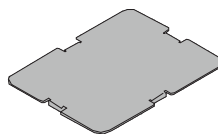

CVR1001

CUTOUT COVER
(BLACK)

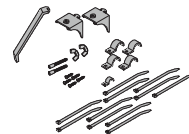

AC401-354

HARDWARE
MOUNTING KIT

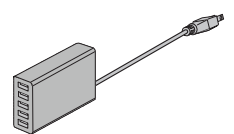

PS5598UB

5V, 5 PORTS USB LOW
PROFILE AC POWER
SUPPLY (U.S.)

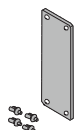

SP1001BL

1 SLOT PLATE-BLANK



SP1002BL

2 SLOT PLATE-BLANK

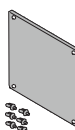

SP1003BL

3 SLOT PLATE-BLANK

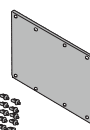

SP1004BL

4 SLOT PLATE-BLANK

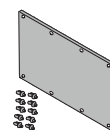

SP1005BL

5 SLOT PLATE-BLANK

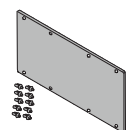

SP1006BL

6 SLOT PLATE-BLANK

Pop 'N Plug (PNP41X series) Dual Sided Shipped Fully Assembled

PNP415 Series

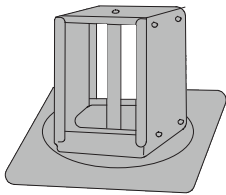

PNP415

CUSTOMIZABLE TOWER SURFACE TABLE TOP, TWO SIDED, 4 EMPTY SLOTS PER SIDE

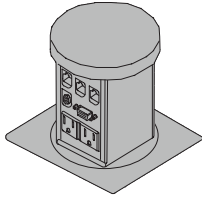

PNP417

TOWER FOR WOOD COVER, TWO SIDED W/ TWO STANDARD SECTIONAL PLATES DS901-120

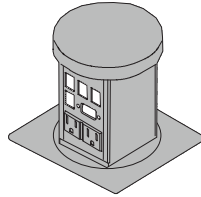

PNP417C

CUSTOM SURFACE COVER, TWO SIDED W/ TWO CUSTOM SECTIONAL PLATES DS901-121

See page 12 for Snap-In connectors
Table Cut-out template is available online
Bezel size: 5.25" Circle
Depth below 1inch table: 7.00 in (178mm)

Factory Configured Insert Plates (can be field upgraded)

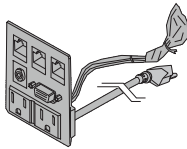

DS901-120

2 AC POWER, 2 RJ45, 1 RJ11, 1 AUDIO & 1 VGA

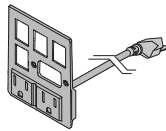

DS901-121

2 POWER, 4 BLANK SNAP-INS, & 1 VGA

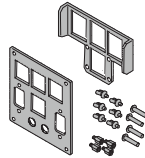

SP3212AV

4 EMPTY SNAP-INS, 2 D-SUBS, 2 AUDIO (3 SLOTS)

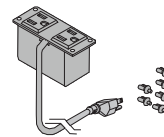

SP2109US

DUAL AC POWER OUTLET FOR U.S. & CANADA (2 SLOTS)

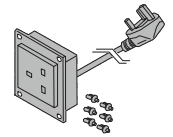

SP2201UK

POWER OUTLET U.K./ SINGAPORE/ HONG KONG (3 SLOTS)

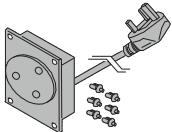

SP2501SA

POWER OUTLET SOUTH AFRICA (3 SLOTS)

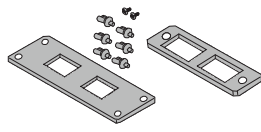

SP3102EP

DUAL EMPTY SNAP-IN PORT (1 SLOT)

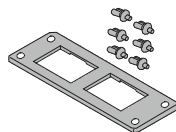

SP3103EP

DUAL EMPTY ORTRONICS-ONLY SNAP-IN PORT(1 SLOT)

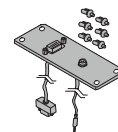

SP3201AV

1 VGA & 1 AUDIO PLAGE (1 SLOT)

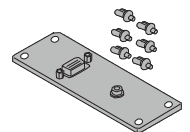

SP3202AV

VGA F/F GENDER CHANGER, 1 AUDIO (1 SLOT)

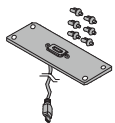

SP3210AV

HDMI SECTIONAL PLATE (1 SLOT)

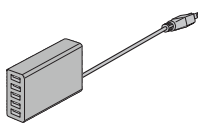

PS5598UB

5V,5 PORTS USB LOW PROFILE AC POWER SUPPLY (U.S)

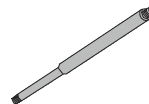

AC401-304

REPLACEMENT GAS SPRING

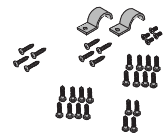

AC401-355

HARDWARE MOUNTING KIT

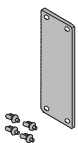

SP1001BL

1 SLOT PLATE-BLANK

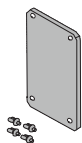

SP1002BL

2 SLOTS PLATE-BLANK

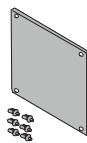

SP1003BL

3 SLOT PLATE-BLANK

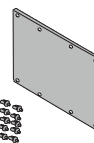

SP1004BL

4 SLOT PLATE-BLANK

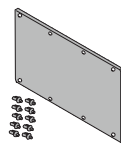

SP1005BL

5 SLOT PLATE-BLANK

PNP515 Series

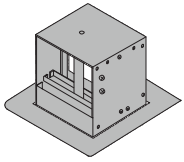

PNP515

CUSTOMIZABLE TABLE TOP
TOWER, NO PLATES

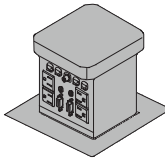

PNP517

TOWER FOR WOOD COVER,
TWO SIDED 4 VGA, 4 AUDIO,
4 RJ45, 2 RCA, 4 RJ11

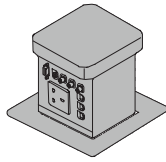

PNP527

U.K. SURFACE TABLE TOP,
WITH 6 RCA, 4 RJ45, 2 RJ11,
2 VGA, 2 AUDIO & 2 POWER

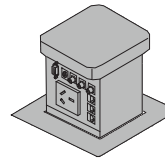

PNP537

AUSTRALIA SURFACE TABLE TOP,
WITH 6 RCA, 4 RJ45, 2 RJ11,
2 VGA, 2 AUDIO & 2 POWER

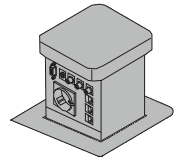

PNP547

GERMANY SURFACE TABLE TOP,
WITH 6 RCA, 4 RJ45, 2 RJ11,
2 VGA, 2 AUDIO & 2 POWER

Factory Configured to Your Specification

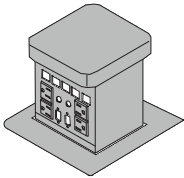

PNP517C

CUSTOMIZABLE TABLE TOP
WITH 10 SNAP-INS, 8 AC
POWER, 2 AUDIO, & 2 D-SUBS

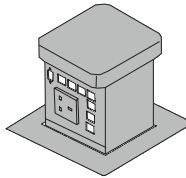

PNP527C

U.K. CUSTOMIZABLE TABLE
TOP, WITH 14 SNAP-INS,
2 D-SUBS, 2 POWER

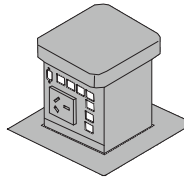

PNP537C

AUSTRALIA CUSTOMIZABLE
TABLE TOP, WITH 14 SNAP-INS,
2 D-SUBS, 2 POWER

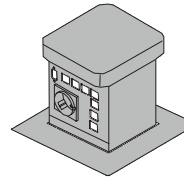

PNP547C

GERMANY CUSTOMIZABLE
TABLE TOP, WITH 14 SNAP-INS,
2 D-SUBS, 2 POWER

See page 12 for Snap-In connectors
Table Cut-out template is available online
Bezel size: 5.85" x 5.65"
Depth below 1inch table: 8.75 in

Factory Configured Insert Plates (can be field upgraded)

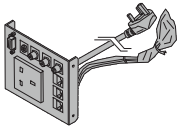

DS901-122

UK POWER RECEPTACLE, WITH
6 RCA, 4 RJ45, 2 RJ11, 2 VGA,
2 AUDIO & 2 POWER

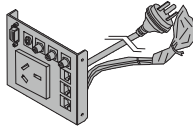

DS901-123

AUSTRALIAN POWER RECEPTACLE,
WITH 6 RCA, 4 RJ45, 2 RJ11,
2 VGA, 2 AUDIO & 2 POWER

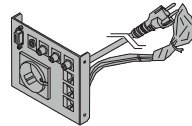

DS901-124

GERMAN POWER RECEPTACLE
WITH 6 RCA, 4 RJ45, 2 RJ11,
2 VGA, 2 AUDIO & 2 POWER

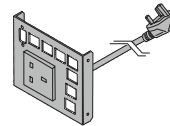

DS901-125

UK POWER ENTRY RECEPTACLE,
WITH 7 BLANK SNAP-IN, & 1 D-SUB

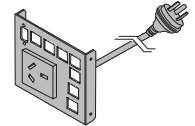

DS901-126

AUSTRALIAN POWER ENTRY
RECEPTACLE, WITH 7 BLANK
SNAP-IN, & 1 D-SUB

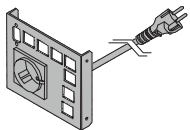

DS901-127

GERMANY POWER
ENTRY RECEPTACLE
WITH 7 BLANK
SNAP-IN, & 1 D-SUB

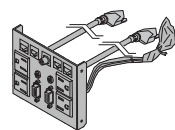

DS901-130

4 AC POWER, 2 VGA,
2 AUDIO, 2 RJ45, 1 RCA,
2 RJ11

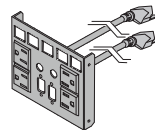

DS901-131

4 AC POWER, 5 BLANK
SNAP-INS, 2 AUDIO, &
2 D-SUBS

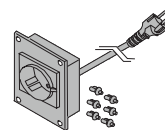

SP2301CE

AC POWER OUTLET
FOR CONTINENTAL
EUROPE (3 SLOTS)

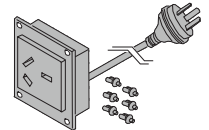

SP2401AU

AC POWER OUTLET
FOR AUSTRALIA/NEW
ZEALAND (3 SLOTS)

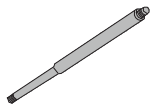

AC401-305

GAS SPRING FOR PNP515 SERIES

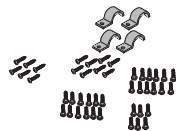

AC401-356

PNP415 HARDWARE MOUNTING
KIT

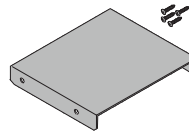

DS901-128

BLANK FACE PLATE

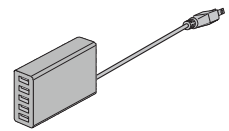

PS5598UB

5V, 5 PORTS USB LOW PROFILE AC
POWER SUPPLY (U.S.)

Tilt 'N Plug (TNP3XX/4XX series)

Standard Units (Brushed Aluminum Bezel)

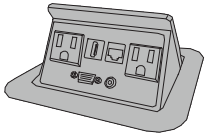

TNP328
(Black)
HDMI, VGA, AUDIO,
RJ45, 2 POWER

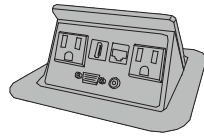

TNP328S
(Silver)
HDMI, VGA, AUDIO,
RJ45, 2 POWER

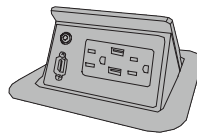

TNP358
(Black)
2 POWER, 2 USB,
HDMI, AUDIO

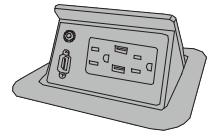

TNP358S
(Silver)
2 POWER, 2 USB,
HDMI, AUDIO

Factory Configured to Your Specification

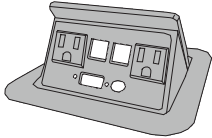

TNP320C
CUSTOMIZABLE TABLE TOP WITH
2 POWER, 2 SNAP-IN CONNECTORS,
1 D-SUB, 1 AUDIO

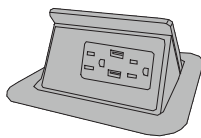

TNP355C
(Chrome plated)
2 POWER, 2 POWERED USB

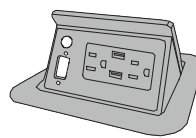

TNP358C
2 POWER, 2 POWERED USB,
CUSTOMIZABLE D-SUB AND AUDIO

See page 12 for Snap-In connectors
Table Cut-out template is available online
Bezel size: 5.7" x 5.2"
Depth below 1inch table: 2.9 in (98mm)

Standard International Units

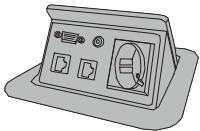

TNP421
(Black)
GERMANY TABLETOP WITH VGA,
3.5 AUDIO, 2 RJ45, & POWER

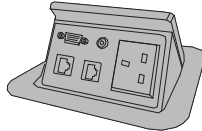

TNP431
(Black)
U.K. TABLETOP WITH VGA,
3.5 AUDIO, 2 RJ45, & POWER

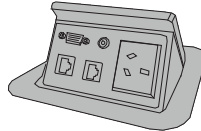

TNP441
(Black)
AUSTRALIA TABLETOP WITH
VGA, 3.5 AUDIO, 2 RJ45, & POWER

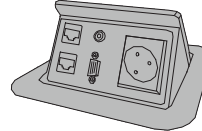

TNP451
(Black)
SOUTH AFRICA TABLETOP WITH
VGA, 3.5 AUDIO, 2 RJ45, & POWER

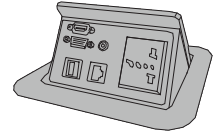

TNP461
(Black)
INDIA TABLETOP WITH VGA, HDMI,
USB, 3.5 AUDIO, RJ45, & POWER

Factory Configured International Units

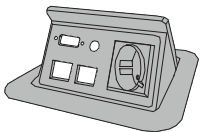

TNP421C
GERMANY POWER WITH
2 SNAP-IN CONNECTORS,
1 D-SUB, & 1 AUDIO

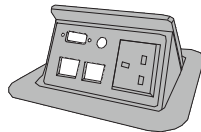

TNP431C
U.K. POWER WITH
2 SNAP-IN CONNECTORS,
1 D-SUB, & 1 AUDIO

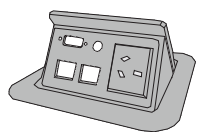

TNP441C
AUSTRALIA POWER WITH
2 SNAP-IN CONNECTORS,
1 D-SUB, & 1 AUDIO

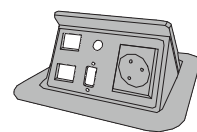

TNP451C
SOUTH AFRICA POWER WITH
2 SNAP-IN CONNECTORS,
1 D-SUB, & 1 AUDIO

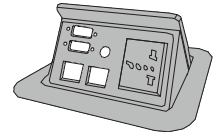

TNP461C
INDIA POWER WITH
2 SNAP-IN CONNECTORS,
1 D-SUB, & 1 AUDIO

Accessories

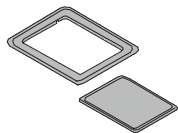

CM11274
MIRROR BLACK BEZEL

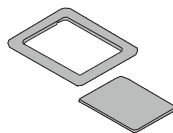

CM12437
BEZEL, BLACK BRUSHED ALUMINUM

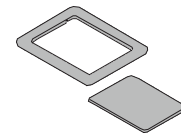

CM12438
BEZEL, SILVER BRUSHED ALUMINUM

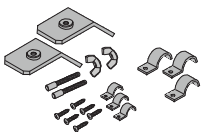

AC401-358
TNP HARDWARE MOUNTING KIT

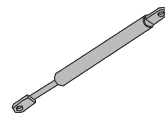

AC401-307
GAS SPRING

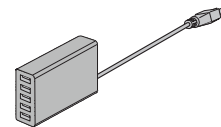

PS5598UB
5V, 5 PORTS USB LOW PROFILE AC
POWER SUPPLY (U.S)

Tilt 'N Plug (TNP5XX/6XX series)

Standard Units (Brushed Aluminum Bezel, Leaf Spring)

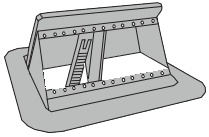

TNP510
(Black)

CUSTOMIZABLE, 6 EMPTY SLOTS

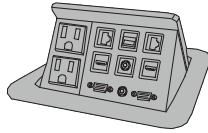

TNP528
(Black)

DUAL HDMI, VGA, AUDIO, RJ45, US POWER, BLACK BRUSHED ALUMINUM

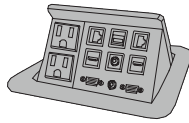

TNP528S
(Silver)

2 RJ45, 1 USB, 2 HDMI, AUDIO, 2 VGA, 2 AC POWER CLEAR BRUSHED ALUMINUM

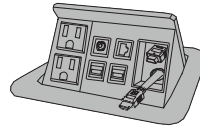

TNP530
(Black)

VGA & HDMI RETRACTABLE CABLE, AUDIO, RJ45, 2 USB BLACK BRUSHED ALUMINUM

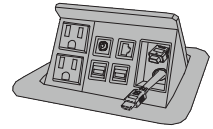

TNP530S
(Silver)

VGA & HDMI RETRACTABLE CABLE, AUDIO, RJ45, 2 USB CLEAR BRUSHED ALUMINUM

Customizable Units (Brushed Aluminum Bezel, Leaf Spring)

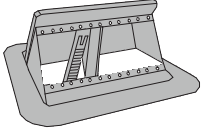

TNP510C
6 EMPTY SLOTS

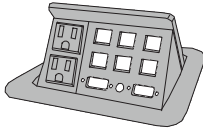

TNP528C
2 POWER, 6 SNAP-IN CONNECTORS, 2 D-SUBS, & 1 AUDIO

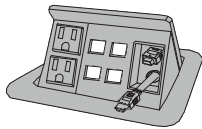

TNP530C
2 POWER, 4 SNAP-IN CONNECTORS, & 2 RETRACTABLE CABLES

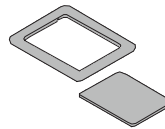

CM11240
BLACK BRUSHED ALUMINUM

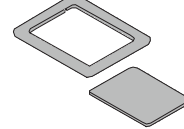

CM11245
SILVER BRUSHED ALUMINUM

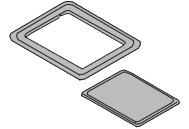

CM11273
MIRROR BLACK BEZEL

Standard Units

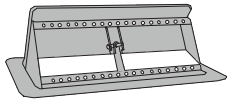

TNP601

10 CUSTOMIZABLE SECTIONAL PLATES

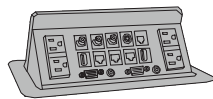

TNP602

TILT 'N PLUG TNP600 WITH DS801-429

Customizable Units

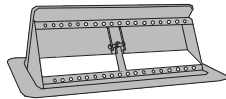

TNP601C

TNP600 WITH SECTIONAL PLATES (10 SLOTS)

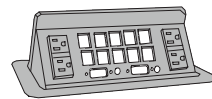

TNP602C

4 POWER, 10 SNAP-INS CONNECTORS, 2 D-SUB, & 2 AUDIO

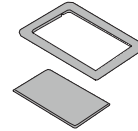

CM12443
BLACK BRUSHED ALUMINUM

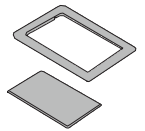

CM12447
SILVER BRUSHED ALUMINUM

Accessories

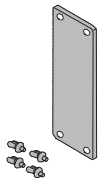

SP1001BL

1 SLOT PLATE-BLANK

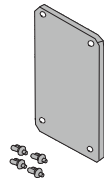

SP1002BL

2 SLOT PLATE-BLANK

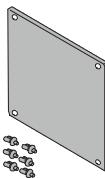

SP1003BL

3 SLOT PLATE-BLANK

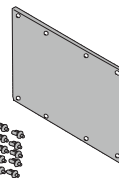

SP1004BL

4 SLOT PLATE-BLANK

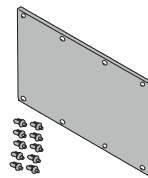

SP1005BL

5 SLOT PLATE-BLANK

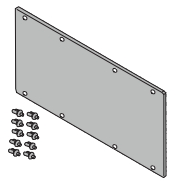

SP1006BL

6 SLOT PLATE-BLANK

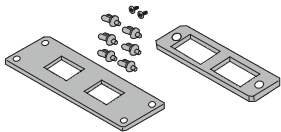

SP3102EP

DUAL EMPTY Keystone SNAP-IN PORT(1 SLOT)

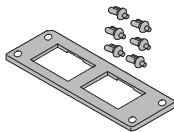

SP3103EP

DUAL EMPTY ORTRONICS-ONLY SNAP-IN PORT(1 SLOT)

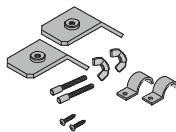

AC401-359

TNP600 HARDWARE MOUNTING KIT

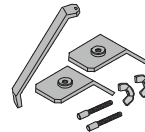

AC401-351

TNP500 HARDWARE MOUNTING KIT

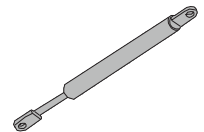

AC401-307

TNP600 GAS SPRING

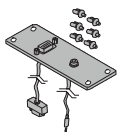

SP3201AV

VGA & AUDIO SECTIONAL PLATE (1 SLOT)

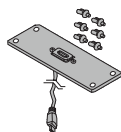

SP3210AV

HDMI SECTIONAL PLATE (1 SLOT)

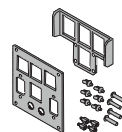

SP3212AV

4 SNAP-INS, 2 AUDIO & 2 D-SUBS SECTIONAL PLATE (3 SLOTS)



SP3501SC

2 RJ45, 1 USB, 2 HDMI, AUDIO, 2 VGA, 2 AC POWER (3 SLOTS)

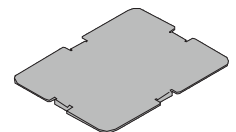

CVR1001

COVER FOR PNP/TNP CUTOUTS (BLACK)

Tilt 'N Plug Jr. (TNP1XX series)

Standard Units (Brushed Aluminum Bezel)

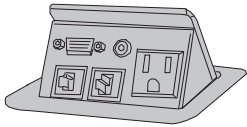

TNP121
(Black)

VGA, AUDIO, RJ45,
RJ11, POWER

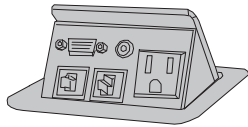

TNP121S
(Silver)

VGA, AUDIO,
RJ45,
RJ11, POWER

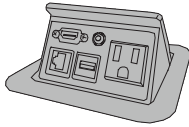

TNP125
(Black)

HDMI, USB,
RJ45, POWER

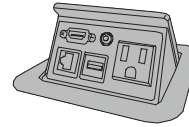

TNP125S
(Silver)

HDMI, USB,
RJ45, POWER

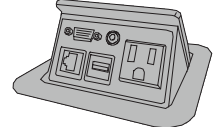

TNP128
(Black)

HDMI, VGA, AUDIO,
RJ45, POWER



TNP128S
(Silver)

HDMI, VGA, AUDIO,
RJ45, POWER

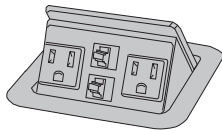

TNP151
(Black)

2 RJ45 & 2 POWER

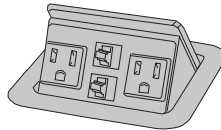

TNP151S
(Silver)

2 RJ45 & 2 POWER

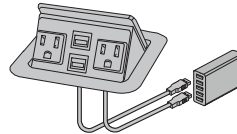

TNP155
(Black)

2 USB & 2 POWER

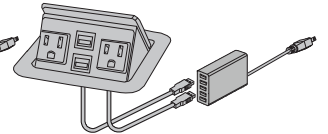

TNP155S
(Silver)

2 USB & 2 POWER

Customizable Units

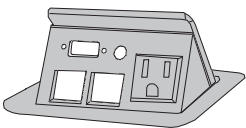

TNP120C

2 SNAP-IN PORTS,
1 D-SUB, 1 AUDIO

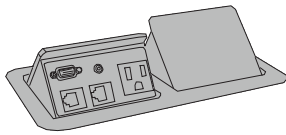

TNP142C

TILT 'N PLUG JR. TWINS (OPPOSITES)

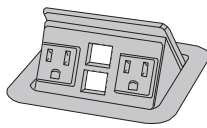

TNP150C

2 SNAP-IN CONNNECTORS,
2 POWER

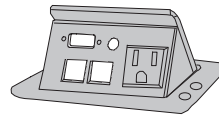

TNP221C

1 D-SUB, 1 AUDIO,
2 SNAP-INS, 1 POWER

See page 12 for Snap-In connectors
Table Cut-out template is available
online
Bezel size: 4.6" x 4.9"
Depth below 1inch table: 2.5 in (90mm)

Bezels

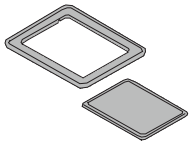

CM11271

MIRROR BLACK BEZEL, COVER
FOR TNP TYPE

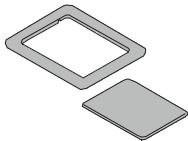

CM12301

TNP121C TOP+ BEZEL, BLACK
ANODIZED FINISH

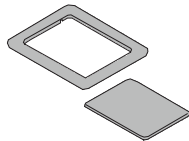

CM12384

TNP121C TOP + BEZEL,
BRUSHED ALUMINUM FINISH

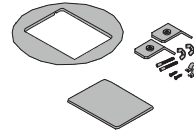

CM12393

TNP JR. TOP + ROUND BEZEL,
BLACK ANODIZED FINISH

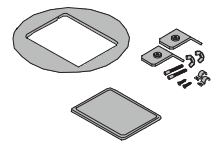

CM12394

TNP JR. TOP + ROUND
BEZEL,CLEAR PAINT FINISH

Stackable Bezels

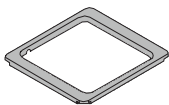

CM12461 (Black)
CM12471 (Silver)

CNK/TNP JR.
STACKABLE BEZEL

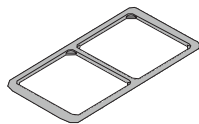

CM12462 (Black)
CM12472 (Silver)

CNK/TNP JR. 2 PORT
STACKABLE BEZEL

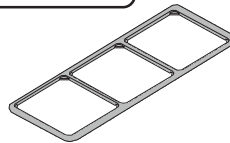

CM12463 (Black)
CM12473 (Silver)

CNK/TNP JR. 3 PORT
STACKABLE BEZEL

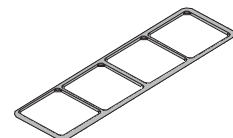

CM12464 (Black)
CM12474 (Silver)

CNK/TNP JR. 4 PORT
STACKABLE BEZEL

Accessories

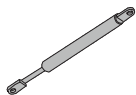

AC401-302

GAS SPRING FOR TNP JR.

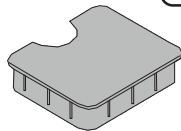

AC300-121

MOLDED TABLE TOP COVER

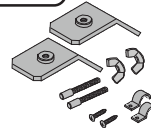

AC401-350

TNP HARDWARE MOUNTING KIT
TNP121/122/125/128/142/151/152/162/221

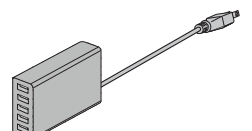

PS5598UB

5V,5 PORTS USB LOW PROFILE AC
POWER SUPPLY (U.S)

Cable Nooks (CNK2XX series)

Standard Units (Brushed Aluminum Bezel)

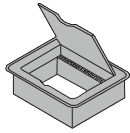

CNK200
(Black)

INTERCONNECT BOX (EMPTY)

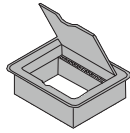

CNK200S
(Silver)

INTERCONNECT BOX (EMPTY)

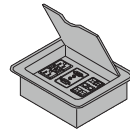

CNK210
(Black)

COMPLETE SP3504SC PLATE

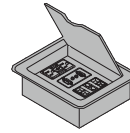

CNK210S
(Silver)

COMPLETE SP3504SC PLATE

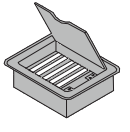

CNK240
(Black)

2 US AC POWER AND
RETAINING BRACKETS

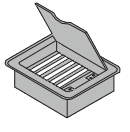

CNK240S
(Silver)

2 US AC POWER AND
RETAINING BRACKETS

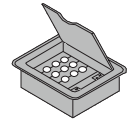

CNK260
(Black)

2 US AC POWER AND
9 RETAINING GROMMETS

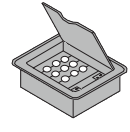

CNK260S
(Silver)

2 US AC POWER AND
9 RETAINING GROMMETS

Plate Inserts

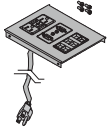

SP3504SC

2 POWER, 2 POWERED USB,
1 HDMI, 2 AUDIO, 1 VGA, 2 RJ45,
4 BLANK SNAP-IN PORTS

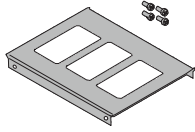

CNK-IP-210

PLATE FOR CNK-IP-2XX

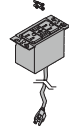

CNK-IP-200

2 AC POWER AND
2 POWERED USB

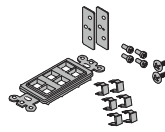

CNK-IP-211

6-PORT SNAP IN
PLATE

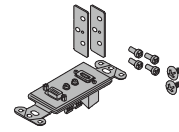

CNK-IP-212

PLATE INSERT WITH
1 HDMI, 1 VGA, 2 AUDIO

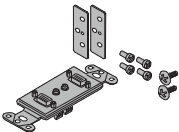

CNK-IP-213

PLATE INSERT WITH
2 VGA & 2 AUDIO

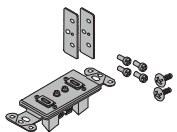

CNK-IP-214

PLATE INSERT WITH
2 HDMI & 2 AUDIO

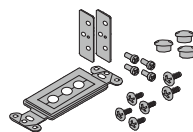

CNK-IP-215

PLATE INSERT WITH
3 GROMMET HOLES,
BLACK,
& 3 GROMMET COVERS

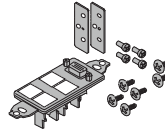

CNK-IP-216

1 VGA & 4 SNAP-IN
PORTS

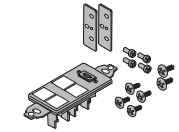

CNK-IP-217

1 HDMI & 4 SNAP-IN
PORTS

Bezels

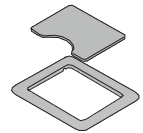

CM12419

TOP & BEZEL,
BLACK ANODIZED

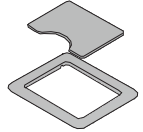

CM12427

TOP & BEZEL,
BRUSHED
ALUMINUM

Customizable Inserts

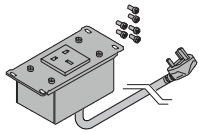

CN5003UK

U.K. AC POWER
MODULE

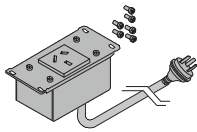

CN5004AU

AUSTRALIAN AC
POWER MODULE

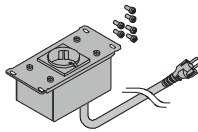

CN5005EU

CONTINENTAL
EUROPE AC POWER
MODULE

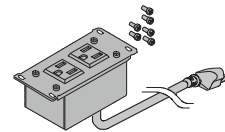

CN5008US

DUAL AC POWER
MODULE

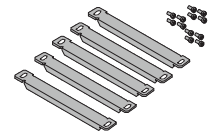

CN5010RB

RETAINING BRACKET FOR
CABLE-NOOK

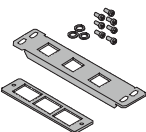

CN5013EP

3 EMPTY SNAP-IN PORTS
INSERT PLATE

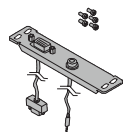

CN5014AV

1 VGA & 1 AUDIO PLATE

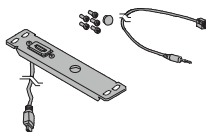

CN5015AV

PLATE INSERT WITH
1 HDMI & 1 AUDIO

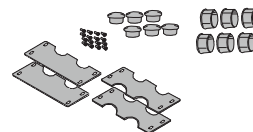

CN5020RG

RETAINING GROMMET, ALLOWS
6 HOLES (US) OR 4 HOLES
(INTERNATIONAL)

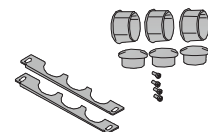

CN5021RG

RETAINING GROMMET,
ALLOWS 3 HOLES

Cable Nooks (CNK6XX)

CNK600 Series

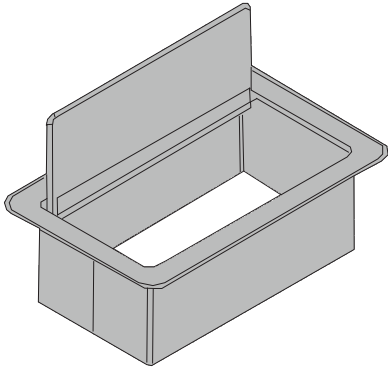

CNK600

Open View
(Black)

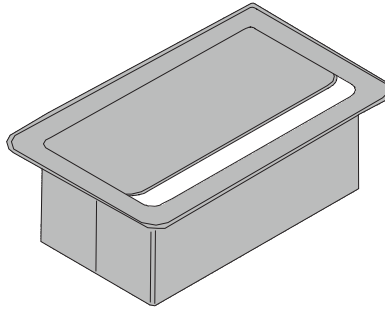

CNK600S

Closed View
(Silver)

INTERCONNECT BOX (EMPTY)
FOR USE WITH SP1106SC

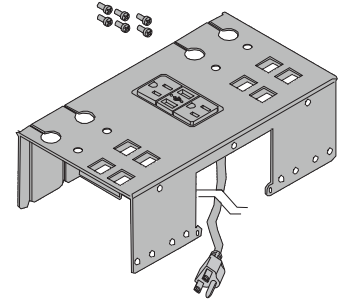

SP1106SC

CUSTOMIZABLE PLATE WITH
2 US POWER, 8 SNAP IN,
4 AUDIO, 4 RETRACTABLE

International Face Plate

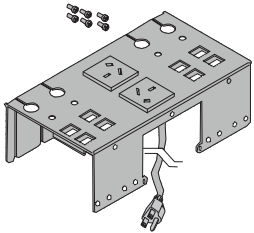

SP1107SC

CUSTOMIZABLE PLATE WITH
2 AUSTRALIA POWER, 8 SNAP IN,
4 AUDIO, 4 RETRACTABLE

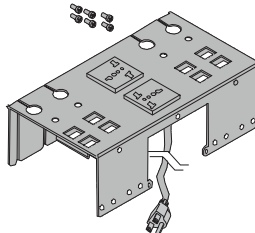

SP1107SC

CUSTOMIZABLE PLATE WITH
2 UNIVERSAL POWER, 8 SNAP IN,
4 AUDIO, 4 RETRACTABLE

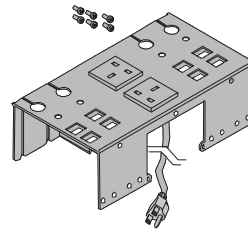

SP1107SC

CUSTOMIZABLE PLATE WITH
2 UK POWER, 8 SNAP IN,
4 AUDIO, 4 RETRACTABLE

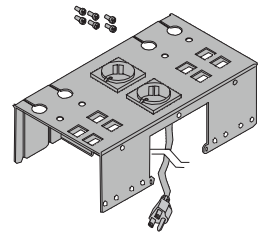

SP1107SC

CUSTOMIZABLE PLATE WITH
2 EUROPE POWER, 8 SNAP IN,
4 AUDIO, 4 RETRACTABLE

Retractable Cables

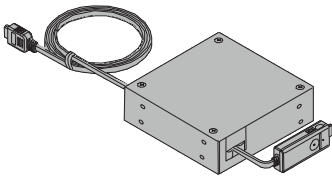

RT300-101

SHARETIME RETRACTABLE
HDMI (M-M) CONTROL CABLE

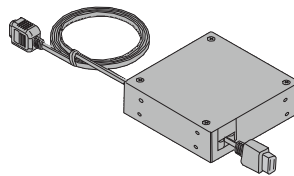

RT300-121

VGA (M-M) RETRACTABLE
CABLE

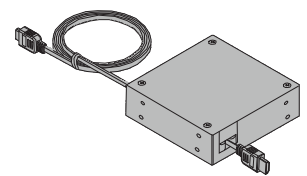

RT300-125

HDMI (M-M) RETRACTABLE
CABLE

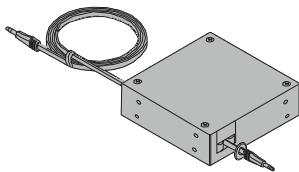

RT300-134

3.5MM (M-M) AUDIO
RETRACTABLE CABLE

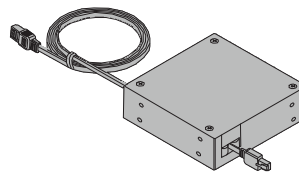

RT300-145

RJ-45 (M-M) RETRACTABLE
CABLE

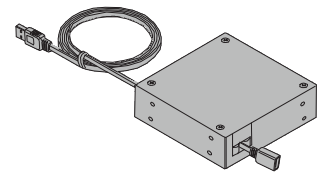

RT300-155

USB (F-M TYPE A)
RETRACTABLE CABLE, F -
RETRACT/M - FIXED

Cable Nooks Jr. (CNK22X/3XX)

Customizable Units

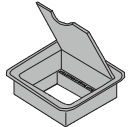

CNK221
(Black)

INTERCONNECT BOX (EMPTY),

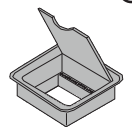

CNK221S
(Silver)

INTERCONNECT BOX (EMPTY)

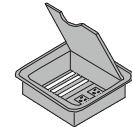

CNK241
(Black)

2 POWER & RETAINING BRACKETS

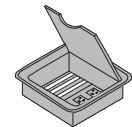

CNK241S
(Silver)

2 POWER & RETAINING BRACKETS

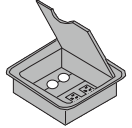

CNK261
(Black)

2 POWER & GROMMETS

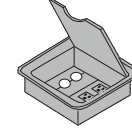

CNK261S
(Silver)

2 POWER & GROMMETS

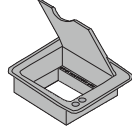

CNK321
(Black)

TABLETOP W DISPLAY SELECT (EMPTY),USED WITH UT260-052

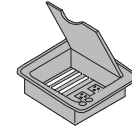

CNK341
(Black)

2 POWER OUTLET, BRACKETS, DISPLAY SELECT,USED WITH UT260-052.

Plate Inserts

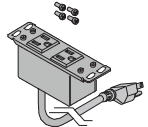

CN5102US
DUAL AC POWER MODULE (9.5FT)

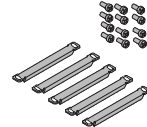

CN5110RB
RETAINING BRACKET

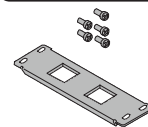

CN6101EP
2 EMPTY SNAP-IN PORTS

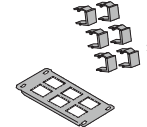

CNK-IP-101
INSERT PLATE FOR 6 SNAP-IN CONNECTORS

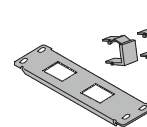

CNK-IP-105
INSERT PLATE FOR 2 EMPTY SNAP-IN PORTS

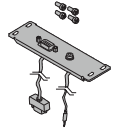

CNK-IP-110
INSERT PLATE WITH 1 VGA & 1 AUDIO

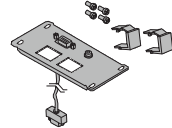

CNK-IP-111
INSERT PLATE WITH 1 VGA, 1 AUDIO & 2 EMPTY SNAP-INS

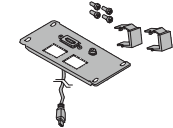

CNK-IP-112
INSERT PLATE WITH 1 HDMI, 1 AUDIO & 2 EMPTY SNAP-INS

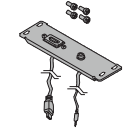

CNK-IP-113
INSERT PLATE WITH 1 HDMI & 1 AUDIO

Stackable Bezels

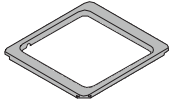

CM12461 (Black)
CM12471 (Silver)
CNK/TNP JR. STACKABLE BEZEL

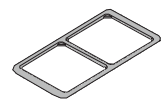

CM12462 (Black)
CM12472 (Silver)
CNK/TNP JR. 2 PORT STACKABLE BEZEL

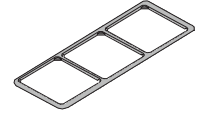

CM12463 (Black)
CM12473 (Silver)
CNK/TNP JR. 3 PORT STACKABLE BEZEL

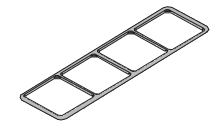

CM12464 (Black)
CM12474 (Silver)
CNK/TNP JR. 4 PORT STACKABLE BEZEL

Bezels

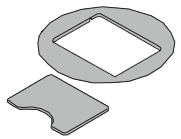

CM12395
ROUND BEZEL, BLACK ANODIZED



CM12396
ROUND BEZEL, CLEAR ALUMINUM

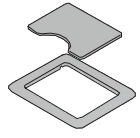

CM12432
BEZEL BRUSHED ALUMINUM

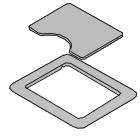

CM12428
BEZEL, BLACK ANODIZED

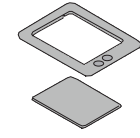

CM11265
TOP COVER, BRUSHED ALUMINUM

Accessories

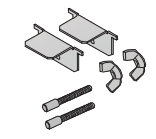

AC401-362
CNK200 CABLE NOOK HARDWARE MOUNTING KIT

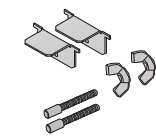

AC401-363
CNK221 CABLE NOOK JR HARDWARE MOUNTING KIT

THE EDGE, UNDER TABLE INTERFACES (UT240-XXX)

Standard Units

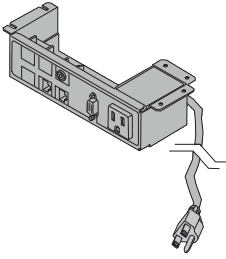

UT240-121S

3 EMPTY SNAP-INS, AUDIO,
1 RJ45, 1 RJ11, 1 VGA & 1
POWER

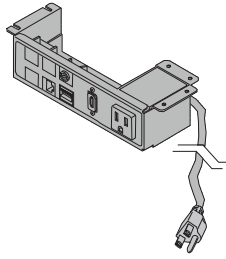

UT240-125S

3 EMPTY SNAP-INS, 1 AUDIO,
1 RJ45, 1 USB, 1 HDMI, 1 POWER

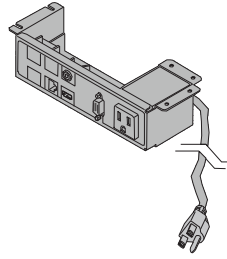

UT240-128S

3 EMPTY SNAP-INS, 1 AUDIO,
1 RJ45, 1 HDMI, 1 VGA, 1 POWER

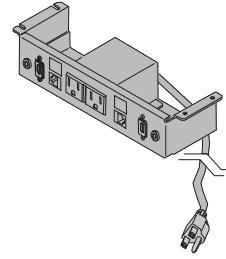

UT240-325S

2 POWER, 2 HDMI, 2 RJ45,
2 AUDIO, 2 BLANK SNAP-IN

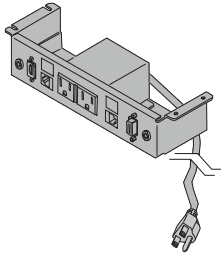

UT240-328S

2 POWER, 2 RJ45,
2 AUDIO, 2 BLANK
SNAP-INS, 1 HDMI, 1 VGA

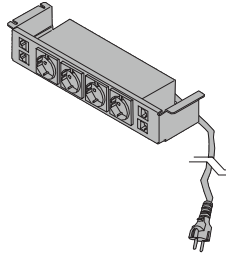

UT240-410

4 EUROPE POWER, 4 RJ45

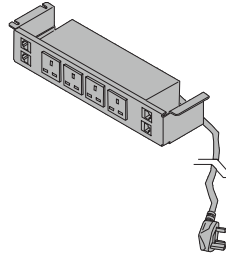

UT240-450

4 U.K. POWER, 4 RJ45

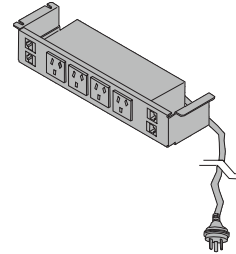

UT240-510

4 AUSTRALIAN POWER, 4 RJ45

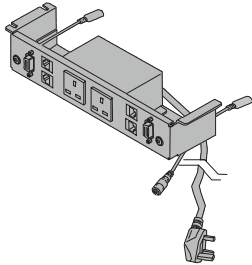

UT240-451

2 U.K. POWER, 2 AUDIO,
2 VGA, 4 RJ45

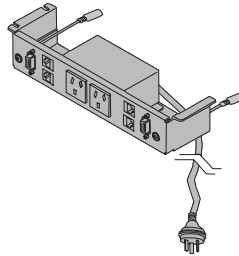

UT240-511

2 AUSTRALIAN POWER, 4 RJ45,
2 VGA, 2 AUDIO

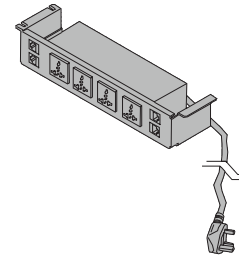

UT240-550

4 UNIVERSAL POWER, 4 RJ45

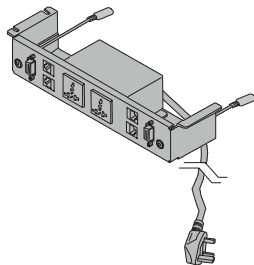

UT240-551

2 UNIVERSAL POWER, 4 RJ45,
2 VGA, 2 AUDIO

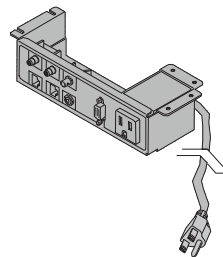

UT240-278

2 RCA, 1 BNC, 1 RJ45,
1 RJ11, 1 AUDIO, 1 VGA, &
1 POWER

Accessories

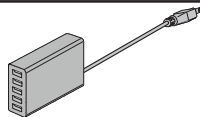

PS5598UB

5V, 5 PORTS USB LOW PROFILE AC
POWER SUPPLY (U.S)

TABLE BUDDY (TBL10X series)

Standard Units

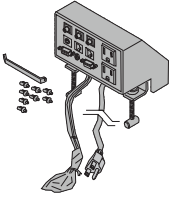

TBL102

3 RCA, 1 S-VIDEO, 1 RJ11,
1, RJ45, 2 VGA,
1 AUDIO, 2 POWER

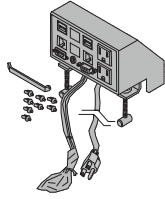

TBL108

2 POWER, 2 USB, 2
RJ45,
2 BLANK SNAP-INS,
1 HDMI, 1 AUDIO, 1 VGA

Customizable Units

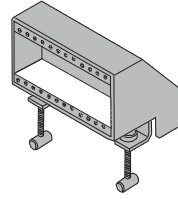

TBL100

CLAMP-ON INPUT
PLATE

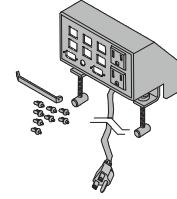

TBL102C

CUSTOMIZABLE,
6 SNAP-INS, 2 D-SUBS,
1 AUDIO, 2 POWER

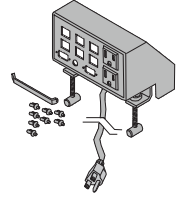

TBL108C

CUSTOMIZABLE,
6 SNAP-INS, 2 D-SUBS,
1 AUDIO, 2 POWER

Plate Inserts

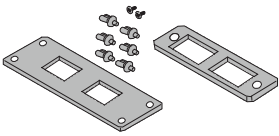

SP3102EP

DUAL EMPTY
Keystone SNAP-IN
PORT(1 SLOT)

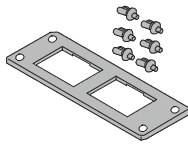

SP3103EP

DUAL EMPTY
ORTRONICS-ONLY SNAP-IN
PORT(1 SLOT)

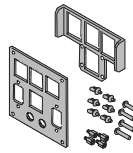

SP3212AV

4 EMPTY SNAP-INS,
2 D-SUBS, 2 AUDIO
(3 SLOTS)

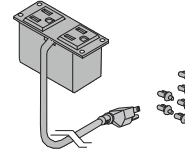

SP2109US

DUAL AC POWER OUTLET
FOR U.S. & CANADA
(2 SLOTS)

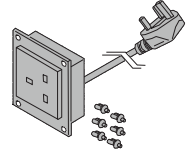

SP2201UK

POWER OUTLET
U.K., SINGAPORE,
HONG KONG (3 SLOTS)

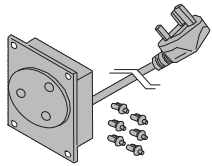

SP2501SA

POWER OUTLET
SOUTH AFRICA
(3 SLOTS)

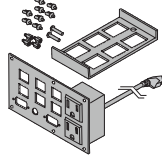

SP1100SC

6 SNAP-INS, 2 D-SUBS,
1 AUDIO, 2 POWER

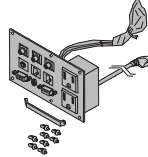

SP3500SC

3 RCA, 1 S-VIDEO,
1 RJ11, 1 RJ45, 2 VGA,
1 AUDIO, 2 POWER

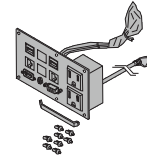

SP3502SC

2 POWER, 2 USB, 2 RJ45,
2 BLANK SNAP-INS,
1 HDMI, 1 AUDIO, 1 VGA

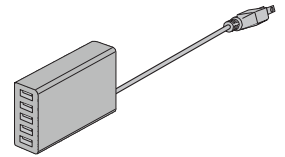

PS5598UB

5V,5 PORTS USB LOW
PROFILE AC POWER
SUPPLY (U.S.)

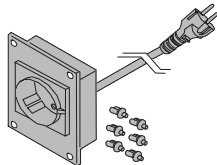

SP2301CE

POWER OUTLET FOR
CONTINENTAL EUROPE
(3 SLOTS)

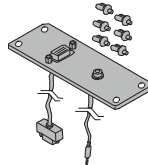

SP3201AV

1 VGA & 1
AUDIO PLAGE
(1 SLOT)

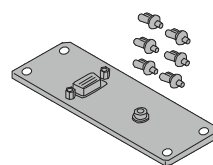

SP3202AV

VGA F/F GENDER
CHANGER, 1 AUDIO
(1 SLOT)

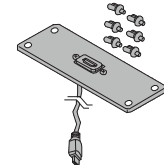

SP3210AV

HDMI SECTIONAL PLATE
(1 SLOT)

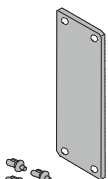

SP1001BL

1 SLOT PLATE-BLANK

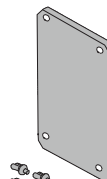

SP1002BL

2 SLOTS PLATE-BLANK

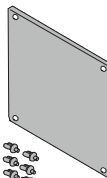

SP1003BL

3 SLOT PLATE-BLANK

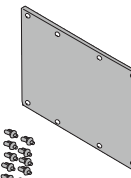

SP1004BL

4 SLOT PLATE-BLANK

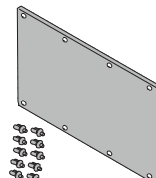

SP1005BL

5 SLOT PLATE-BLANK

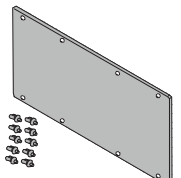

SP1006BL

6 SLOT PLATE-BLANK

Additional Solutions

Distribution

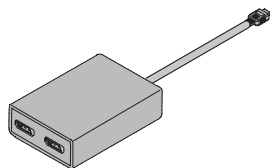

DA103-302
HDMI 1 X 2 DA W/BUILT-IN INPUT
CABLE

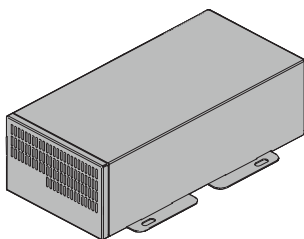

MU400-111
STAND ALONE PWR TX, HDMI
TX + IR + RS232, 150W,250W
POWER SUPPLY

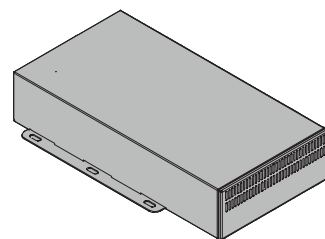

MU500-112
STAND ALONE PWR RX, HDMI
RX+ IR+RS232, 150W

Converters

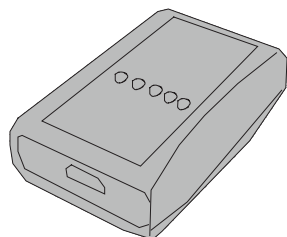

DIGI SNIFFER
DIGITAL VIDEO SIGNAL TESTER

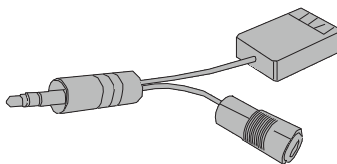

SC206-204
UNBALANCED TO BALANCED
AUDIO ADAPTER W/ LOOP

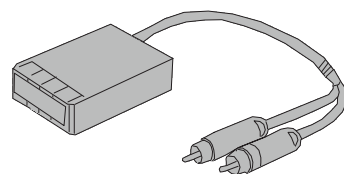

SC206-205
UNBALANCED TO BALANCED AUDIO
ADAPTER W/ LOOP (RCA TO 5p TB)

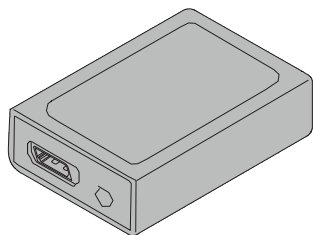

VP500-100
HDMI TO VGA CONVERTER

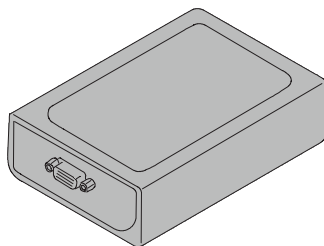

VP500-101
VGA TO HDMI CONVERTER

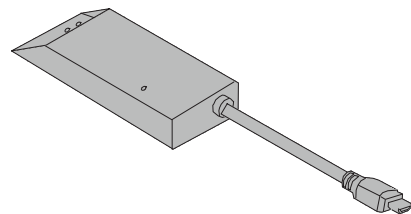

VP500-102
UNIVERSAL DIGITAL SCALER

Collaborations

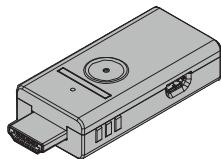

ST100-001
SHARETIME COLLABORATIVE
CONTROLLER,CEC TOUCH
CONTROL WITH POWER ON/OFF

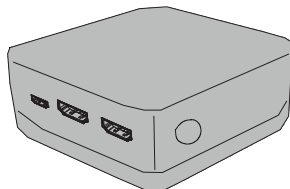

UT260-041
UNDER-TABLE SMART 4X1 HDMI
SWITCHER

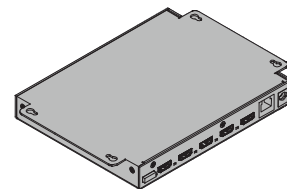

UT260-052
UNDER TABLE 5X2 HDMI SW
SHOW ME + IP

Cables

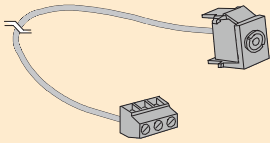

CM11305

3.5MM STEREO AUDIO F/TB 6FT SNAP-IN ASSEMBLY

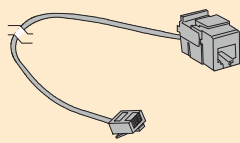

CM11306

RJ-11, GREY F/M 6FT SNAP-IN ASSEMBLY

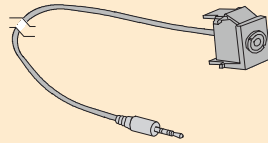

CM11316

3.5MM STEREO AUDIO 6FT F/M SNAP-IN ASSEMBLY

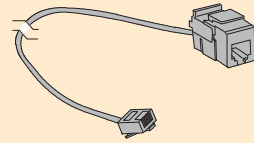

CM11318

RJ-11 6 PINS M/F SNAP-IN ASSEMBLY

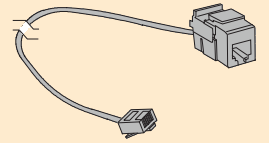

CM11319

RJ-11 6 PINS 6FT M/F BLACK SNAP-IN ASSEMBLY

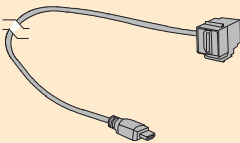

CM11341

HDMI F/M 6FT BLACK SNAP-IN ASSEMBLY

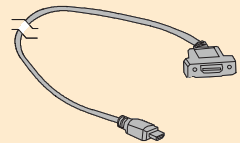

CM11342

HDMI F/M 6FT CABLE ASSEMBLY

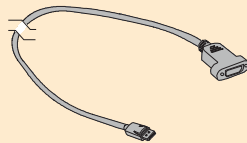

CM11343

DP F/M 6FT CABLE ASSEMBLY

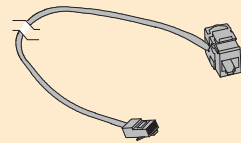

CM11350

CAT-6 RJ-45 F/M 6FT RED SNAP-IN ASSEMBLY

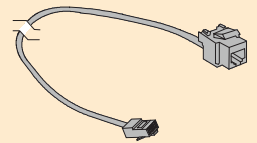

CM11351

CAT-6 RJ-45 F/M 6FT RED SNAP-IN ASSEMBLY

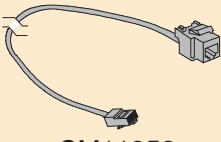

CM11352

CAT-6 RJ-45 F/M 6FT BLACK SNAP-IN ASSEMBLY

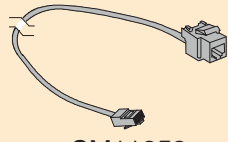

CM11353

CAT-6 RJ-45 F/M 6FT YELLOW SNAP-IN ASSEMBLY



CM11354

CAT-6 RJ-45 F/M 6FT GREEN SNAP-IN ASSEMBLY



CM11355

CAT-6 RJ-45 F/M 6FT BLUE SNAP-IN ASSEMBLY

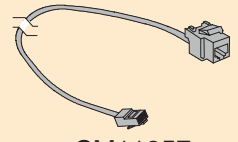

CM11357

CAT-6 RJ-45 F/M 6FT IVORY SNAP-IN ASSEMBLY

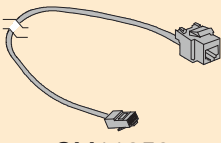

CM11358

CAT-6 RJ-45 F/M 6FT IVORY SNAP-IN ASSEMBLY

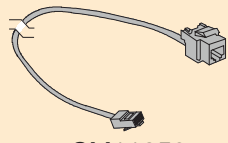

CM11359

CAT-6 RJ-45 F/M 6FT ORANGE SNAP-IN ASSEMBLY

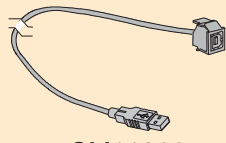

CM11366

USB "B" F / USB "A" M 6FT SNAP IN ASSEMBLY

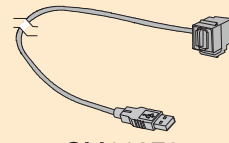

CM11370

USB 3.0 TYPE A F / USB A M 6FT SNAP IN ASSEMBLY

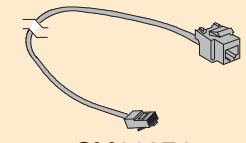

CM11374

CAT-6 RJ-45 F/M 6FT RED SNAP-IN (TIA568A)

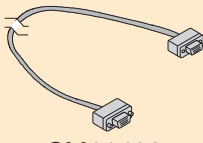

CM11402

15-PIN HD F/F 6FT PANEL MOUNT CABLE ASSEMBLY

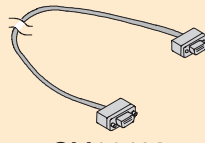

CM11403

9-PIN D F/F 6FT PANEL MOUNT CABLE ASSEMBLY

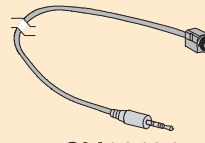

CM11404

3.5MM STEREO F/M 6FT PANEL MOUNT CABLE ASSEMBLY

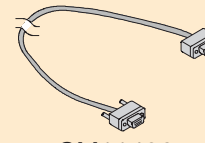

CM11406

15-PIN HD F/M 6FT PANEL MOUNT CABLE ASSEMBLY

Blank Covers

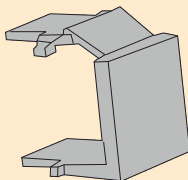

CM11301

BLANK BLACK SNAP-IN COVER

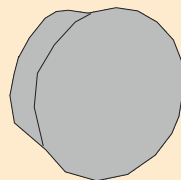

CM11405

COVER, BLACK 3.5MM AUDIO PANEL MOUNT

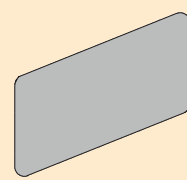

CM11401

9 OR 15 PIN D-SUB COVER - BLACK

Retractable Cables & Active Cables

Retractable Cables

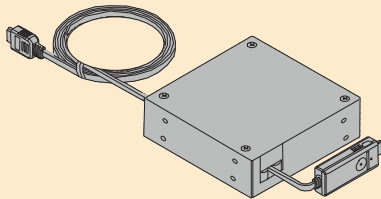

RT300-101
SHARETIME RETRACTABLE
HDMI (M-M) CONTROL CABLE

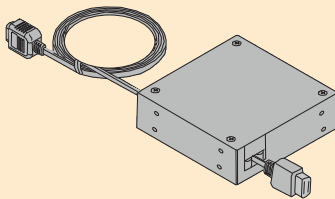

RT300-121
VGA (M-M) RETRACTABLE
CABLE

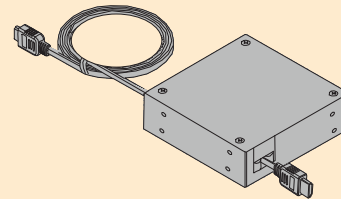

RT300-125
HDMI (M-M) RETRACTABLE
CABLE

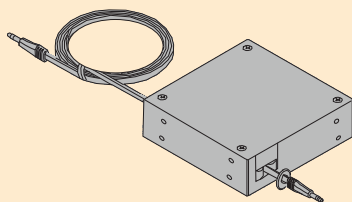

RT300-134
3.5MM (M-M) AUDIO
RETRACTABLE CABLE

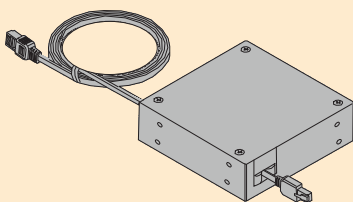

RT300-145
RJ-45 (M-M) RETRACTABLE
CABLE

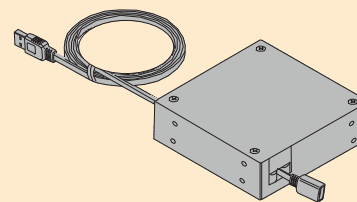

RT300-155
USB (F-M TYPE A)
RETRACTABLE CABLE, F -
RETRACT/M - FIXED

Accessories

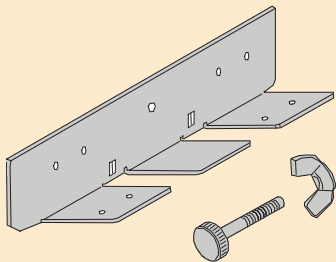

AG200-125
RT300-xxx MOUNTING
HARDWARE FOR CNK200

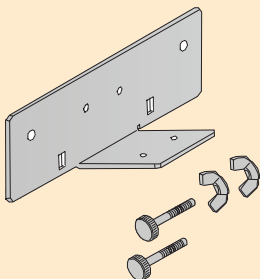

AG221-125
RT300-xxx MOUNTING
HARDWARE FOR CNK221

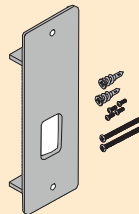

AC225-125B (Black)
AC225-125I (Ivory)
AC225-125W (White)

RT300-XXX WALL MOUNT
BRACKET, 2X6 WALL

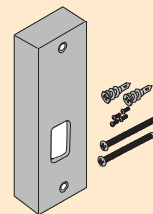

AC225-126B (Black)
AC225-126I (Ivory)
AC225-126W (White)

RT300-XXX WALL MOUNT
BRACKET, 2X4 WALL

HDMI

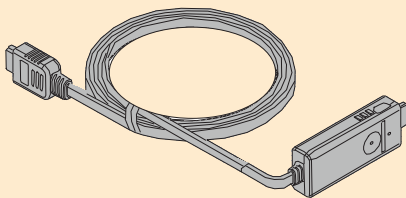

CB300-101
10FT SHARETIME HDMI CABLE

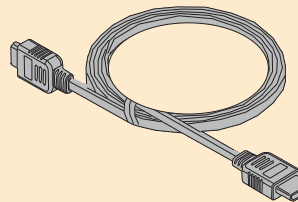

CB300-102
10FT ACTIVE FLAT HDMI
CABLE